

Carbon Steel ASME/ANSI Flanges – Dimensions & Weights

These diagrams relate to the tables of flange specified dimensions on the following pages.

The Notes shown on this page also relate to the tables on the following pages.

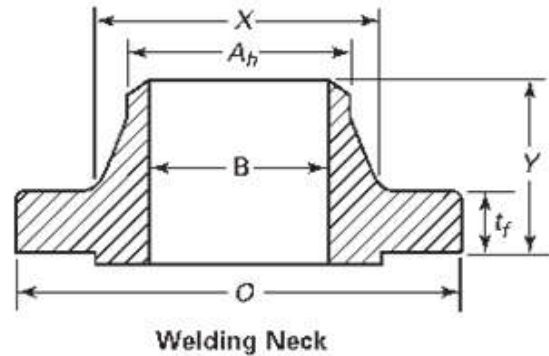
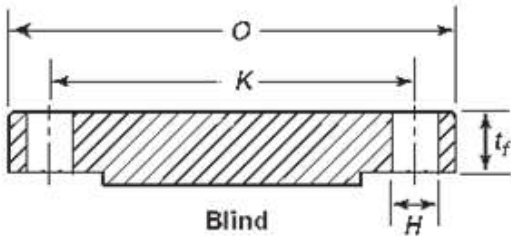
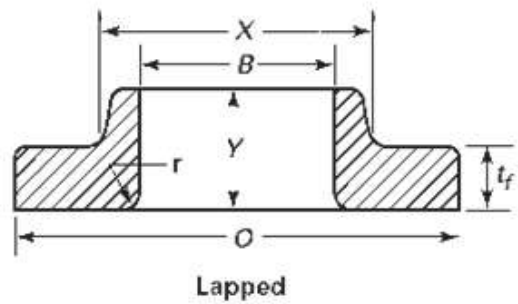
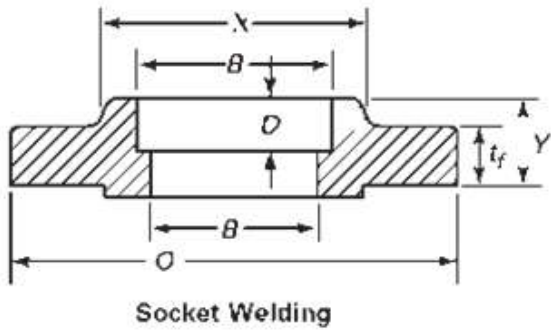
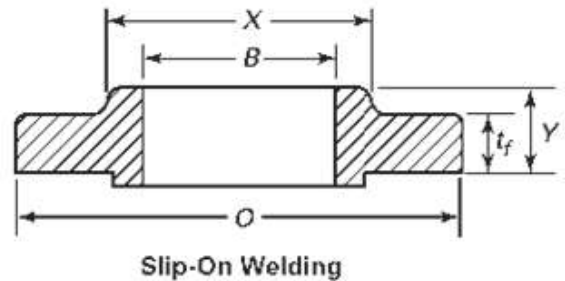
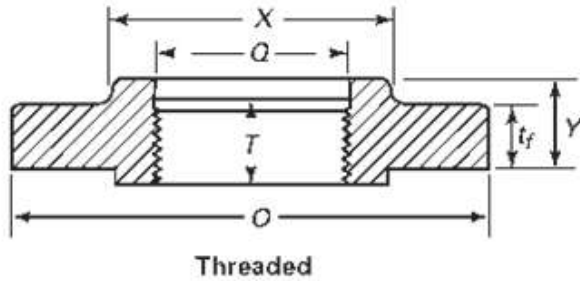

Note 1: To be specified by purchase

Note 2: Flange weights are approximate

Note 3: Welding neck flange bore sizes listed are for sch 40S / Standard Wall pipe

Carbon Steel ASME/ANSI Flanges – Dimensions & Weights

Class 150 Flanges to ASME B16.5																	
Nominal Size		Dimensions													Flange Weight (kg)		
DN	NPS	Flange OD (mm) O	Thick-ness min (mm) t _f	Hub Diam. (mm) X	Hub Diam. Welding Neck (mm) A _n	Length Thru Hub		Bore		Bolt Drilling					Slip-on	Welding Neck	Blind
						Slip-on/Socket Welding (mm) Y	Welding Neck (mm) Y	Slip-on/Socket Welding min (mm) B	Welding Neck / Socket Welding (mm) B	Circle Diam. (mm) K	Hole Diam. (mm) H	Bolts (No.)	RF Stud Bolt Length (mm)	RF Machine Bolt Length (mm)			
15	½	90	9.6	30	21.3	14	46	22.2	15.8	60.3	15.9	4	55	50	0.4	0.5	0.4
20	¾	100	11.2	38	26.7	14	51	27.7	20.9	69.9	15.9	4	65	50	0.6	0.7	0.6
25	1	110	12.7	49	33.4	16	54	34.5	26.6	79.4	15.9	4	65	55	0.8	1.0	0.9
32	1 ¼	115	14.3	59	42.2	19	56	43.2	35.1	88.9	15.9	4	70	55	1.0	1.3	1.2
40	1 ½	125	15.9	65	48.3	21	60	49.5	40.9	98.4	15.9	4	70	65	1.3	1.7	1.5
50	2	150	17.5	78	60.3	24	62	61.9	52.5	120.7	19.1	4	85	70	2.1	2.6	2.4
65	2 ½	180	20.7	90	73.0	27	68	76.6	62.7	139.7	19.1	4	90	75	3.3	4.1	3.9
80	3	190	22.3	108	88.9	29	68	90.7	77.9	152.4	19.1	4	90	75	3.9	4.9	4.9
90	3 ½	215	22.3	122	101.6	30	70	103.4	90.1	177.8	19.1	8	90	75	4.8	6.1	6.2
100	4	230	22.3	135	114.3	32	75	116.1	102.3	190.5	19.1	8	90	75	5.3	6.8	7.0
125	5	255	22.3	164	141.3	35	87	143.8	128.2	215.9	22.2	8	95	85	6.1	8.6	8.5
100	4	230	22.3	135	114.3	32	75	116.1	102.3	190.5	19.1	8	90	75	5.3	6.8	7.0
125	5	255	22.3	164	141.3	35	87	143.8	128.2	215.9	22.2	8	95	85	6.1	8.6	8.6
150	6	280	23.9	192	168.3	38	87	170.7	154.1	241.3	22.2	8	100	85	7.5	11	11
200	8	345	27.0	246	219.1	43	100	221.5	202.7	298.5	22.2	8	110	90	12	18	20
250	10	405	28.6	305	273.0	48	100	276.2	254.6	362.0	25.4	12	115	100	17	24	29
300	12	485	30.2	365	323.8	54	113	327.0	304.8	431.8	25.4	12	120	100	26	37	43
350	14	535	33.4	400	355.6	56	125	359.2	Note (1)	476.3	28.6	12	135	115	35	48	58
400	16	595	35.0	457	406.4	62	125	410.5	Note (1)	539.8	28.6	16	135	115	45	61	76
450	18	635	38.1	505	457.0	67	138	461.8	Note (1)	577.9	31.8	16	145	125	49	68	94
500	20	700	41.3	559	508.0	71	143	513.1	Note (1)	635.0	31.8	20	160	140	62	85	122
600	24	815	46.1	663	610.0	81	151	616.0	Note (1)	749.3	34.9	20	170	150	87	115	186

Class 300 Flanges to ASME B16.5																	
Nominal Size		Dimensions													Flange Weight (kg)		
DN	NPS	Flange OD (mm) O	Thick-ness min (mm) t _f	Hub Diam. (mm) X	Hub Diam. Welding Neck (mm) A _n	Length Thru Hub		Bore		Bolt Drilling					Slip-on	Welding Neck	Blind
						Slip-on/Socket Welding (mm) Y	Welding Neck (mm) Y	Slip-on/Socket Welding min (mm) B	Welding Neck / Socket Welding (mm) B	Circle Diam. (mm) K	Hole Diam. (mm) H	Bolts (No.)	RF Stud Bolt Length (mm)	RF Machine Bolt Length (mm)			
15	½	95	12.7	38	21.3	21	51	22.2	15.8	66.7	15.9	4	65	55	0.6	0.8	0.6
20	¾	115	14.3	48	26.7	24	56	27.7	20.9	82.6	19.1	4	75	65	1.2	1.3	1.2
25	1	125	15.9	54	33.4	25	60	34.5	26.6	88.9	19.1	4	75	65	1.4	1.6	1.4
32	1 ¼	135	17.5	64	42.2	25	64	43.2	35.1	98.4	19.1	4	85	70	1.7	2.1	1.8
40	1 ½	155	19.1	70	48.3	29	67	49.5	40.9	114.3	22.2	4	90	75	2.6	3.1	2.7
50	2	165	20.7	84	60.3	32	68	61.9	52.5	127.0	19.1	8	90	75	2.9	3.4	3.1
65	2 ½	190	23.9	100	73.0	37	75	74.6	62.7	149.2	22.2	8	100	85	4.5	5.3	4.8
80	3	210	27.0	117	88.9	41	78	90.7	77.9	168.3	22.2	8	110	90	6.2	7.3	6.8
90	3 ½	230	28.6	133	101.6	43	79	103.4	90.1	184.2	22.2	8	110	95		8.2	9.5
100	4	255	30.2	146	114.3	46	84	116.1	102.3	200.0	22.2	8	115	95		11	12
125	5	280	33.4	178	141.3	49	97	143.8	128.2	235.0	22.2	8	120	110		15	16
150	6	320	35.0	206	168.3	51	97	170.7	154.1	269.9	22.2	12	120	110		20	21
200	8	380	39.7	260	219.1	60	110	221.5	202.7	330.2	25.4	12	140	120		30	35
250	10	445	46.1	321	273.0	65	116	276.2	254.6	387.4	28.6	16	160	140		44	55
300	12	520	49.3	375	323.8	71	129	327.0	304.8	450.8	31.8	16	170	145		64	79
350	14	585	52.4	425	355.6	75	141	359.2	Note (1)	514.4	31.8	20	180	160		88	107
400	16	650	55.6	483	406.4	81	144	410.5	Note (1)	571.5	34.9	20	190	165		113	139
450	18	710	58.8	533	457.0	87	157	461.8	Note (1)	628.6	34.9	24	195	170		138	177
500	20	775	62.0	587	508.0	94	160	513.1	Note (1)	685.8	34.9	24	205	185		167	223
600	24	915	68.3	702	610.0	105	167	616.0	Note (1)	812.8	41.3	24	230	205		235	342

These flanges are available in a very wide range of sizes, ratings and types in 304/304L and 316/316L. Other grades such as 2205 are available subject to enquiry.

Carbon Steel ASME/ANSI Flanges – Dimensions & Weights

Class 600 Flanges to ASME B16.5																
Nominal Size		Dimensions												Flange Weight (kg)		
DN	NPS	Flange OD (mm) O	Thick-ness min (mm) t _t	Hub Diam. (mm) X	Hub Diam. Welding Neck (mm) A _h	Length Thru Hub		Bore		Bolt Drilling				Slip-on	Welding Neck	Blind
						Slip-on/Socket Welding (mm) Y	Welding Neck (mm) Y	Slip-on/Socket Welding min (mm) B	Welding Neck / Socket Welding (mm) B	Circle Diam. (mm) K	Hole Diam. (mm) H	Bolts (No.)	RF Stud Bolt Length (mm)			
15	½	95	14.3	38	21.3	22	52	22.2	Note (1)	66.7	15.9	4	75	0.9	0.9	0.9
20	¾	115	15.9	48	26.7	25	57	27.7	Note (1)	82.6	19.1	4	90	1.4	1.6	1.4
25	1	125	17.5	54	33.4	27	62	34.5	Note (1)	88.9	19.1	4	90	1.8	1.9	1.8
32	1 ¼	135	20.7	64	42.2	29	67	43.2	Note (1)	98.4	19.1	4	95	2.6	2.5	2.4
40	1 ½	155	22.3	70	48.3	32	70	49.5	Note (1)	114.3	22.2	4	110	3.2	3.6	3.4
50	2	165	25.4	84	60.3	37	73	61.9	Note (1)	127.0	19.1	8	110	3.9	4.5	4.4
65	2 ½	190	28.6	100	73.0	41	79	74.6	Note (1)	149.2	22.2	8	120	5.9	6.4	6.8
80	3	210	31.8	117	88.9	46	83	90.7	Note (1)	168.3	22.2	8	125	7.4	8.1	8.9
90	3 ½	230	35.0	133	101.6	49	86	103.4	Note (1)	184.	25.4	8	140		12	13
100	4	275	38.1	152	114.3	54	102	116.1	Note (1)	215.9	25.4	8	145		17	19
125	5	330	44.5	189	141.3	60	114	143.8	Note (1)	266.7	28.6	8	165		31	31
150	6	355	47.7	222	168.3	67	117	170.7	Note (1)	292.1	28.6	12	170		37	38
200	8	420	55.6	273	219.1	76	133	221.5	Note (1)	349.2	31.8	12	190		51	62
250	10	510	63.5	343	273.0	86	152	276.2	Note (1)	431.8	34.9	16	215		86	102
300	12	560	66.7	400	323.8	92	156	327.0	Note (1)	489.0	34.9	20	220		103	132
350	14	605	69.9	432	355.6	94	165	359.2	Note (1)	527.0	38.1	20	235		122	158
400	16	685	76.2	495	406.4	106	178	410.5	Note (1)	603.2	41.3	20	255		177	225
450	18	745	82.6	546	457.0	117	184	461.8	Note (1)	654.0	44.5	20	275		216	285
500	20	815	88.9	610	508.0	127	190	513.1	Note (1)	723.9	44.5	24	285		268	365
600	24	940	101.6	718	610.0	140	203	616.0	Note (1)	838.2	50.8	24	330		372	533

Class 900 Flanges to ASME B16.5																
Nominal Size		Dimensions												Flange Weight (kg)		
DN	NPS	Flange OD (mm) O	Thick-ness min (mm) t _t	Hub Diam. (mm) X	Hub Diam. Welding Neck (mm) A _h	Length Thru Hub		Bore		Bolt Drilling				Slip-on	Welding Neck	Blind
						Slip-on/Socket Welding (mm) Y	Welding Neck (mm) Y	Slip-on/Socket Welding min (mm) B	Welding Neck / Socket Welding (mm) B	Circle Diam. (mm) K	Hole Diam. (mm) H	Bolts (No.)	RF Stud Bolt Length (mm)			
15	½	120	22.3	38	21.3	32	60	22.2	Note (1)	82.6	22.2	4	110	1.8	2.1	1.9
20	¾	130	25.4	44	26.7	35	70	27.7	Note (1)	88.9	22.2	4	115	2.3	2.7	2.7
25	1	150	28.6	52	33.4	41	73	34.5	Note (1)	101.6	25.4	4	125	3.4	3.9	4.1
32	1 ¼	160	28.6	64	42.2	41	73	43.2	Note (1)	111.1	25.4	4	125	4.1	4.5	4.3
40	1 ½	180	31.8	70	48.3	44	83	49.5	Note (1)	123.8	28.6	4	140	5.5	5.9	5.9
50	2	215	38.1	105	60.3	57	102	61.9	Note (1)	165.1	25.4	8	145	11	11	11
65	2 ½	245	41.3	124	73.0	64	105	74.6	Note (1)	190.5	28.6	8	160	16	16	16
80	3	240	38.1	127	88.9	54	102	90.7	Note (1)	190.5	25.4	8	145	12	15	13
100	4	290	44.5	159	114.3	70	114	116.1	Note (1)	235.0	31.8	8	170	23	23	25
125	5	350	50.8	190	141.3	79	127	143.8	Note (1)	279.4	34.9	8	190	38	39	39
150	6	380	55.6	235	168.3	86	140	170.7	Note (1)	317.5	31.8	12	190	48	50	52
200	8	470	63.5	298	219.1	102	162	221.5	Note (1)	393.7	38.1	12	220	75	79	59
250	10	545	39.9	368	273.0	108	184	276.2	Note (1)	469.9	38.1	16	235	111	118	132
300	12	610	79.4	419	323.8	117	200	327.0	Note (1)	533.4	38.1	20	255	146	157	187
350	14	640	85.8	451	355.6	130	213	359.2	Note (1)	558.8	41.3	20	275	172	182	224
400	16	705	88.9	508	406.4	133	216	410.5	Note (1)	616.0	44.5	20	285	193	225	272
450	18	785	101.6	565	457.0	152	229	461.8	Note (1)	685.8	50.8	20	325	272	309	386
500	20	855	108.0	622	508.0	159	248	513.1	Note (1)	749.3	54.0	20	350	331	377	488
600	24	1040	139.7	749	610.0	203	292	616.0	Note (1)	901.7	66.7	20	440	632	685	905

These flanges are available in a very wide range of sizes, ratings and types in 304/304L and 316/316L. Other grades such as 2205 are available subject to enquiry.

Carbon Steel ASME/ANSI Flanges – Dimensions & Weights

Class 1500 Flanges to ASME B16.5																
Nominal Size		Dimensions												Flange Weight (kg)		
DN	NPS	Flange OD (mm) O	Thick-ness min (mm) t _r	Hub Diam. (mm) X	Hub Diam. Welding Neck (mm) A _n	Length Thru Hub		Bore		Bolt Drilling				Slip-on	Welding Neck	Blind
						Slip-on/Socket Welding (mm) Y	Welding Neck (mm) Y	Slip-on/Socket Welding min (mm) B	Welding Neck / Socket Welding (mm) B	Circle Diam. (mm) K	Hole Diam. (mm) H	Bolts (No.)	RF Stud Bolt Length (mm)			
15	½	120	22.3	38	21.3	32	60	22.2	Note (1)	82.6	22.2	4	110	1.8	2.1	1.9
20	¾	130	25.4	44	26.7	35	70	27.7	Note (1)	88.9	22.2	4	115	2.8	2.7	2.7
25	1	150	28.6	52	33.4	41	73	34.5	Note (1)	101.6	25.4	4	125	3.6	3.9	4.1
32	1 ¼	160	28.6	64	42.2	41	73	43.2	Note (1)	111.1	25.4	4	125	5.0	4.5	4.3
40	1 ½	180	31.8	70	48.3	44	83	49.5	Note (1)	123.8	28.6	4	140	6.8	5.9	5.9
50	2	215	38.1	105	60.3	57	102	61.9	Note (1)	165.1	25.4	8	145	11	11	11
65	2 ½	245	41.3	124	73.0	64	105	74.6	Note (1)	190.5	28.6	8	160	16	16	16
80	3	265	47.7	133	88.9		117		Note (1)	203.2	31.8	8	180		22	22
100	4	310	54.0	162	114.3		124		Note (1)	241.3	34.9	8	195		31	33
125	5	375	73.1	197	141.3		156		Note (1)	292.1	41.3	8	250		59	60
150	6	395	82.6	229	168.3		171		Note (1)	317.5	38.1	12	260		75	75
200	8	485	92.1	292	219.1		213		Note (1)	393.7	44.5	12	290		124	137
250	10	585	108.0	368	273.0		254		Note (1)	482.6	50.8	12	335		206	230
300	12	675	123.9	451	323.8		283		Note (1)	571.5	54.0	16	375		306	316
350	14	750	133.4	495	355.6		298		Note (1)	635.0	60.3	16	405		416	421
400	16	825	146.1	552	406.4		311		Note (1)	704.8	66.7	16	445		568	559
450	18	915	162.0	597	457.0		327		Note (1)	774.7	73.0	16	495		736	761
500	20	985	177.8	641	508.0		356		Note (1)	831.8	79.4	16	540		929	967
600	24	1170	203.2	762	610.0		406		Note (1)	990.6	92.1	16	615		1504	1568

Class 2500 Flanges to ASME B16.5																
Nominal Size		Dimensions												Flange Weight (kg)		
DN	NPS	Flange OD (mm) O	Thick-ness min (mm) t _r	Hub Diam. (mm) X	Hub Diam. Welding Neck (mm) A _n	Length Thru Hub		Bore		Bolt Drilling				Slip-on	Welding Neck	Blind
						Slip-on/Socket Welding (mm) Y	Welding Neck (mm) Y	Slip-on/Socket Welding min (mm) B	Welding Neck / Socket Welding (mm) B	Circle Diam. (mm) K	Hole Diam. (mm) H	Bolts (No.)	RF Stud Bolt Length (mm)			
15	½	135	30.2	43	21.3	40	73	22.9	Note (1)	88.9	22.2	4	120	3.0	3.2	3.2
20	¾	140	31.8	51	26.7	43	79	28.2	Note (1)	95.2	22.2	4	125	3.6	4.1	4.5
25	1	160	35.0	57	33.4	48	89	34.9	Note (1)	108.0	25.4	4	140	5.0	5.5	5.4
32	1 ¼	185	38.1	73	42.2	52	95	43.7	Note (1)	130.2	28.6	4	150	7.3	9.1	8.2
40	1 ½	205	44.5	79	48.3	60	111	50.0	Note (1)	146.0	31.8	4	170	10	11	10
50	2	235	50.9	95	60.3	70	127	62.5	Note (1)	171.4	28.6	8	180	17	19	18
65	2 ½	265	57.2	114	73.0	79	143	75.4	Note (1)	196.8	31.8	8	195	24	24	25
80	3	305	66.7	133	88.9	92	168	91.4	Note (1)	228.6	34.9	8	220	36	43	39
100	4	355	76.2	165	114.3	108	190	116.8	Note (1)	273.0	41.3	8	255	54	64	60
125	5	420	92.1	203	141.3	130	229	144.4	Note (1)	323.8	47.6	8	300	93	111	101
150	6	485	108.0	235	168.3	152	273	171.4	Note (1)	368.3	54.0	8	345	143	176	157
200	8	550	127.0	305	219.1	178	318	222.2	Note (1)	438.2	54.0	12	380	213	261	241
250	10	675	165.1	375	273.0	229	419	277.4	Note (1)	539.8	66.7	12	490	409	484	465
300	12	760	184.2	441	323.8	254	464	328.2	Note (1)	619.1	73.0	12	540	573	692	664

These flanges are available in a very wide range of sizes, ratings and types in 304/304L and 316/316L. Other grades such as 2205 are available subject to enquiry.

Carbon Steel Table Flanges – Dimensions & Weights

These diagrams relate to the tables of flange specified dimensions on the following pages. Refer note below regarding terminology of Table flange types.

Types of Table Flanges specified in AS 2129.

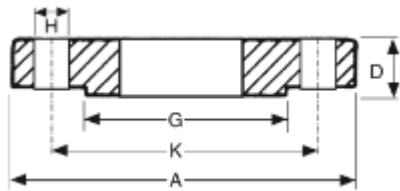
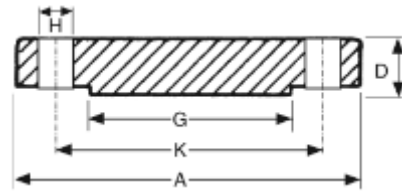
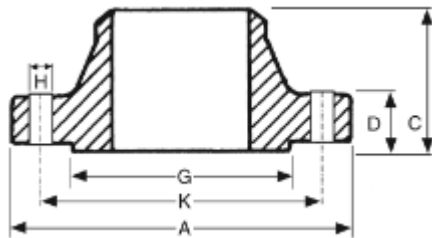

PLATE
"SLIP-ON WELDING"



BLIND
("BLANK")



WELDING NECK (WN)

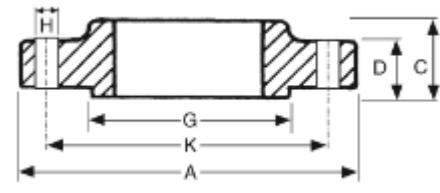

BOSS

Notes to these diagrams and the following tables of dimensions.

- Diagrams above show the optional Raised Face.
- Standard Atlas Steels Table Flange stock is Flat Faced.
- All weights are approximate
- A diametrical clearance of 4mm maximum applies to pipe or tube OD for plate flanges
- The flange thickness "D" dimension includes the raised face height, if a non-standard raised sealing face is present.
- Welding Neck bore is derived from the pipe schedule
- Atlas standard stock table flanges are plate and blind type. Note that AS2129 plate flanges are usually referred to by end users as "slip-on welding" flanges and this terminology is also used in Atlas product descriptions.
- PN16 "DIN" flanges to EN1092-1 and AS4087 waterworks flanges are also available subject to enquiry.

Carbon Steel Table Flanges – Dimensions & Weights

Nominal Size	Dimensions (mm)							Weight (kg)	
	DN	OD A	Thickness D	Raised Face Diam. G	Drilling			Bolt Size & Thread	SOW
Bolt Circle Diam. K					Bolt Hole Diam. H	Number of Bolts			
15	95	*5	47	67	14	4	M12	0.6	0.6
20	100	*5	53	73	14	4	M12	0.7	0.7
25	115	*5	65	83	14	4	M12	0.9	1.0
32	120	*6	67	87	14	4	M12	0.9	1.1
40	135	*6	78	98	14	4	M12	1.2	1.4
50	150	*8	90	114	18	4	M16	1.4	1.7
65	165	*8	103	127	18	4	M16	1.6	2.1
80	185	*10	122	146	18	4	M16	2.0	2.7
90	205	*10	141	165	18	4	M16	2.2	3.2
100	215	*10	154	178	18	4	M16	2.5	3.6
125	255	13	186	210	18	8	M16	3.3	4.9
150	280	13	211	235	18	8	M16	4.0	6.1
200	335	13	268	292	18	8	M16	5.0	8.8
250	405	16	328	356	22	8	M20	8.7	15.8
300	455	19	378	406	22	12	M20	11.3	23.6
350	525	22	438	470	26	12	M24	19.6	38.6
400	580	22	489	521	26	12	M24	22.3	44.9
450	640	25	532	584	26	12	M24	29.0	63.0
500	705	29	609	641	26	16	M24	39.9	86.0
550	760	29	637	699	30	16	M27	50.0	107.0
600	825	32	720	756	30	16	M27	58.0	125.0
700	910	35	809	845	30	20	M27		
750	995	41	888	927	33	20	M30		
800	1060	41	942	984	36	20	M33		
850	1090	44	974	1016	36	20	M33		
900	1175	48	1050	1092	36	24	M33		
1000	1255	51	1133	1175	36	24	M33		
1200	1490	60	1368	1410	36	32	M33		

Nominal Size	Dimensions (mm)							Weight (kg)	
	DN	OD A	Thickness D	Raised Face Diam. G	Drilling			Bolt Size & Thread	SOW
Bolt Circle Diam. K					Bolt Hole Diam. H	Number of Bolts			
15	95	*6	47	67	14	4	M12	0.6	0.7
20	100	*6	53	73	14	4	M12	0.7	0.8
25	115	*7	63	83	14	4	M12	0.9	1.0
32	120	*8	67	87	14	4	M12	1.0	1.1
40	135	*9	78	98	14	4	M12	1.2	1.4
50	150	*10	90	114	18	4	M16	1.4	1.7
65	165	*10	103	127	18	4	M16	1.6	2.1
80	185	*11	122	146	18	4	M16	2.0	2.7
90	205	12	141	165	18	8	M16		
100	215	13	154	178	18	8	M16	2.5	3.6
125	255	14	186	210	18	8	M16	3.7	5.5
150	280	17	207	235	22	8	M20	5.0	8.3
200	335	19	264	292	22	8	M20	7.1	12.9
250	405	22	328	356	22	12	M20	11.4	21.9
300	455	25	374	406	26	12	M24	15.1	31.8
350	525	29	438	470	26	12	M24	25.3	47.6
400	580	32	489	521	26	12	M24	31.3	66.0
450	640	35	552	584	26	16	M24	40.8	87.0
500	705	38	609	641	26	16	M24	53.0	114.0
550	760	44	663	699	30	16	M27		
600	825	48	717	756	33	16	M30	85.0	195.0
700	910	51	806	845	33	20	M30		
750	995	54	885	927	36	20	M33		
800	1060	54	942	984	36	20	M33		
850	1090	57	974	1016	36	20	M33		
900	1175	64	1050	1092	36	24	M33		
1000	1255	67	1130	1175	39	24	M36		
1200	1490	79	1365	1410	39	32	M36		

Carbon Steel Table Flanges – Dimensions & Weights

Nominal Size	Dimensions (mm)							Weight (kg)	
	DN	OD A	Thickness D	Raised Face Diam. G	Drilling			Bolt Size & Thread	SOW
Bolt Circle Diam. K					Bolt Hole Diam. H	Number of Bolts			
15	95	10	47	67	14	4	M12	0.6	0.7
20	100	10	53	73	14	4	M12	0.7	0.8
25	120	10	63	87	18	4	M16	0.9	1.0
32	135	13	74	98	18	4	M16	1.1	1.3
40	140	13	81	105	18	4	M16	1.2	1.4
50	165	16	103	127	18	4	M16	2.2	2.6
65	185	16	122	146	18	4	M16	2.5	3.0
80	205	16	141	165	18	8	M16	3.0	3.8
90	215	19	154	178	18	8	M16		
100	230	19	167	191	18	8	M16	4.3	5.9
125	280	22	207	235	22	8	M20	7.4	10.1
150	305	22	232	260	22	12	M20	8.1	11.9
200	370	35	296	324	22	12	M20	12.7	20.3
250	430	29	349	381	26	12	M24	18.1	31.4
300	490	32	406	438	26	16	M24	23.9	44.7
350	550	35	459	495	30	16	M27	35.3	63.0
400	610	41	516	552	30	20	M27	47.6	90.0
450	675	44	571	610	33	20	M30	62.0	120.0
500	735	51	634	673	33	24	M30	80.0	162.0
550	785	54	685	724	33	24	M30		
600	850	57	739	781	36	24	M33	112.0	
700	935	60	815	857	36	24	M33		
750	1015	67	898	940	36	28	M33		
800	1060	68	942	984	36	28	M33		
850	1090	70	974	1016	36	32	M33		
900	1185	76	1060	1105	39	32	M36		
1000	1275	83	1149	1194	39	36	M36		
1200	1530	95	1385	1441	42	40	M39		

Nominal Size	Dimensions (mm)							Weight (kg)	
	DN	OD A	Thickness D	Raised Face Diam. G	Drilling			Bolt Size & Thread	SOW
Bolt Circle Diam. K					Bolt Hole Diam. H	Number of Bolts			
15	115	57	57	83	18	4	M16	0.8	1.0
20	115	57	57	83	18	4	M16	0.9	1.0
25	120	64	64	87	18	4	M16	1.1	1.2
32	135	76	76	98	18	4	M16	1.5	1.8
40	140	83	83	105	18	4	M16	1.7	2.0
50	165	102	102	127	18	4	M16	2.6	3.1
65	185	114	114	146	18	8	M16	3.1	3.8
80	205	127	127	165	18	8	M16	4.3	5.4
90	215	140	140	178	18	8	M16		
100	230	152	152	191	18	8	M16	5.8	7.9
125	280	178	178	235	22	8	M20	9.9	12.6
150	305	210	210	260	22	12	M20	10.8	15.4
200	370	260	260	324	22	12	M20	18.3	28.2
250	430	311	311	381	26	12	M24	22.1	38.0
300	490	362	362	438	26	16	M24	31.0	58.0
350	550	419	419	495	30	16	M27	47.7	85.0
400	610	483	483	552	30	20	M27	62.0	118.0
450	675	533	533	610	33	20	M30	105.0	196.0
500	735	597	597	673	33	24	M30		
550	785	648	648	724	33	24	M30		
600	850	699	699	781	36	24	M33		